

M1920 COMPACT WINDLASS PUSHER TENSIONER WITH SHEAR

ITW Strapbinder®

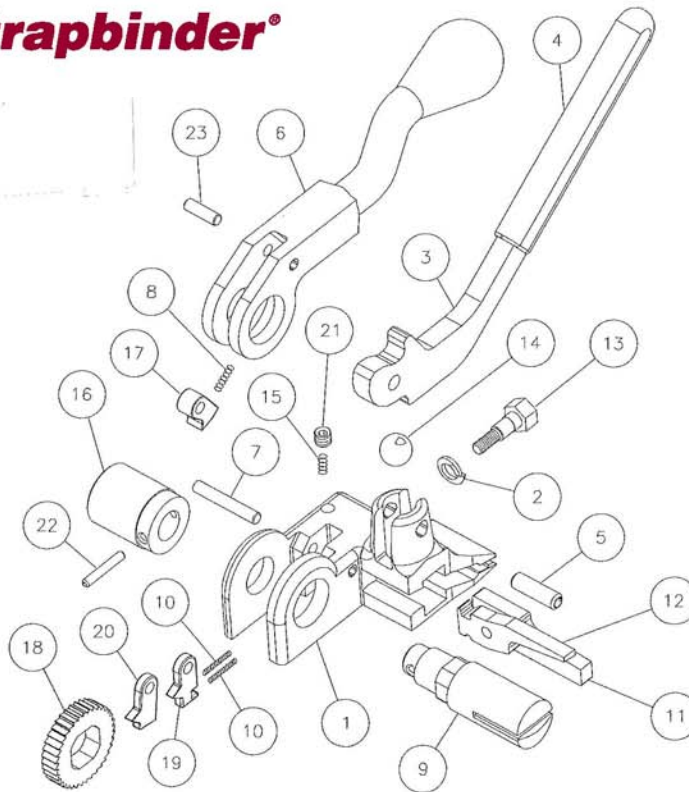

KEY#	DESCRIPTION	QTY	PART#	KEY#	DESCRIPTION	QTY	PART#
1	Base	1	M1920-1	13	Shear Blade Screw	1	M1920-13
2	Lock Washer	1	M1920-2	14	Shear Blade Ball	1	M1920-14
3	Shear Lever	1	M1920-3	• 15	Shear Blade Spring	1	M1920-15
4	Grip	1	M1920-4	• 16	Hammer Knob	1	M1920-16
5	Shear Lever Spring Pin	1	M1920-5	• 17	Drive Pawl	1	M1920-17
6	Tension Lever	1	M1920-6	• 18	Ratchet Wheel	1	M1920-18
7	Base Dowel Pin	1	M1920-7	• 19	Short Stop Pawl	1	M1920-19
• 8	Drive Pawl Spring	1	M1920-8	• 20	Long Stop Pawl	1	M1920-20
9	Tension Shaft	1	M1920-9	• 21	Set Screw	1	M1920-21
• 10	Stop Pawl Spring	2	M1920-10	• 22	Hammer Spring Pin	1	M1920-22
• 11	Lower Shear Blade	1	M1920-11	• 23	Tens. Lever Dowel Pin	1	M1920-23
• 12	Upper Shear Blade	1	M1920-12				

Reference part number when ordering. Read all operating & safety instructions. [•] Indicates wear part.

SAFETY WARNINGS:

- Before operating the tool, review the enclosed Acme Safety booklet. Only trained personnel should operate Acme hand tools.
- Keep fingers away from areas that can pinch or cut. These areas are primarily located at the front of the tool.
- Only use equipment recommended for the strap. The M1920 is recommended only for .015 – .031 gauge steel strap, 3/8” – 3/4” wide.
- Review the instructions and safety material on a regular basis.
- **Warning:** Improper use may result in blindness, severe laceration, amputation, or death.

M1920 OPERATING INSTRUCTIONS

OPERATING INSTRUCTIONS:

1. Slide strap through seal, with wings facing away from operator and pointing up.



2. Pull strap through seal, around package, and through the seal a second time protruding about four inches from the seal.

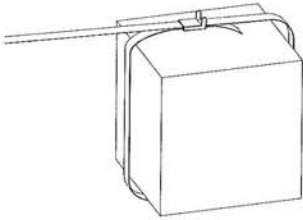

3. Bend back the lower layer of strap to form a hook around the bottom of the seal. Pull strap snug about package, with seal approximately one inch from the edge, as shown.

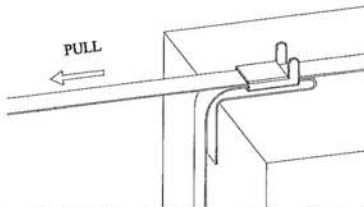

4. Line up the tension shaft slot with the slot in the nose.

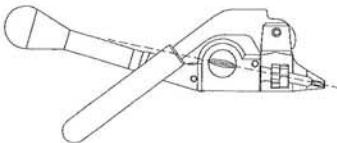

5. With the tool in the left hand and strap in the right, insert the strap through the nose and tension shaft slots.

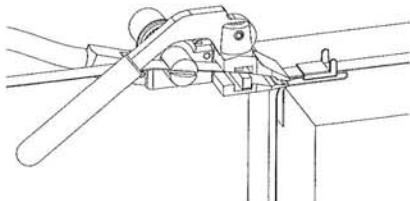

6. Holding the shear lever with the right hand, push the tension lever back and forth in a full arc with the left hand to tighten the strap.

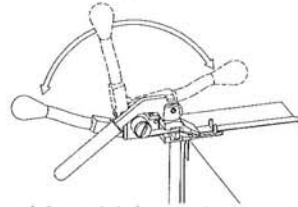

7. With strap tightened, bring tension lever back to original position, hold both handles together, and tilt forward as shown.

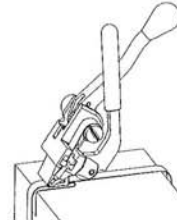

8. Holding tension lever with left hand, push the shear lever downward with the right hand to cut the strap.

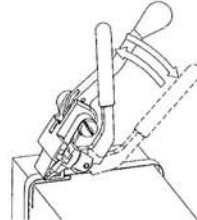

9. While pulling the tool forward and away from seal with the right hand, press the cut strap down between the wings with the left thumb.

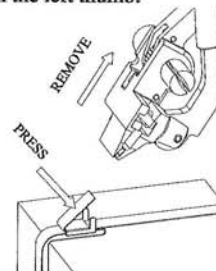

10. Hammer down wings securely using hammer knob on tensioner, or a similar tool.

